

NEW HIGH SPEED INTEGRATED AMPLIFIER

3261

SERVICE MANUAL

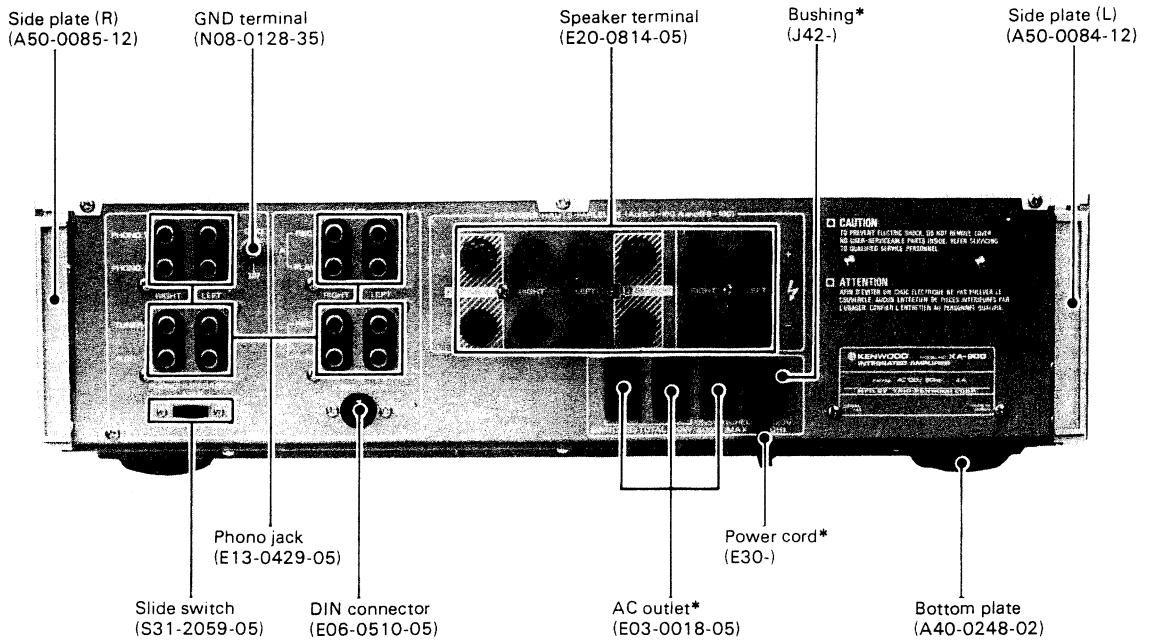
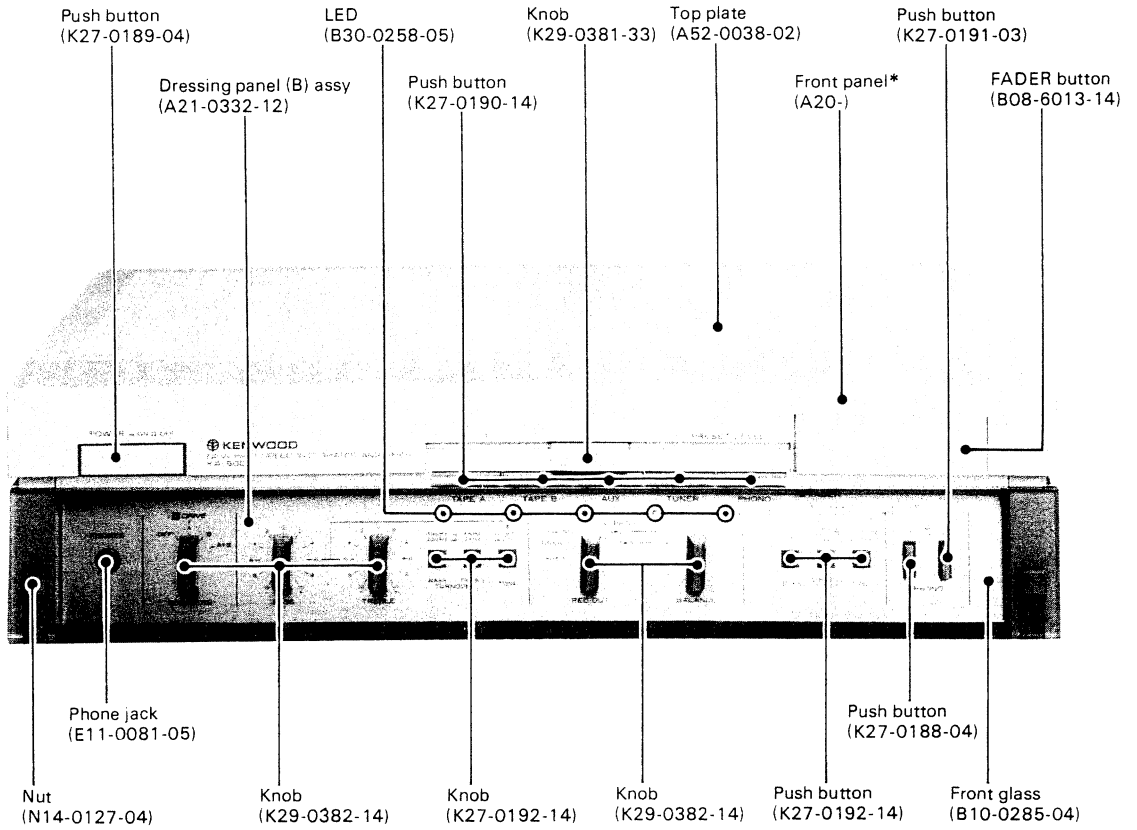

*Refer to Parts List on page 10.

3261

DIAL CORD STRINGING/BLOCK DIAGRAM

DIAL CORD STRINGING

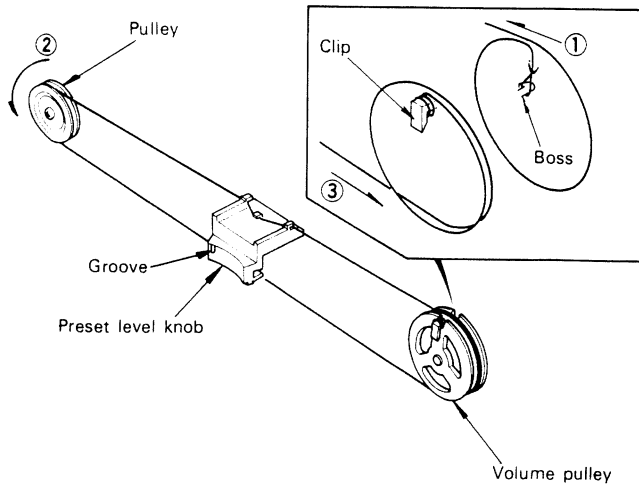

1. Tie the dial cord to the boss of volume pulley.
2. Set volume pulley to the volume shaft and turn it counterclockwise till it stops.
3. Dress the dial cord to volume pulley counterclockwise 1 turn starting from the upper side as shown (①).
4. Stretch and hook the dial cord to the pulley and dress it to the volume pulley from the lower side 1 and a half turn (② ③).
5. Be sure to wind the end of the dial cord firmly to the clip of the volume pulley, so that it is tightly stretched.
6. Make sure that volume pulley is fully turned counterclockwise and fix the preset level knob by adhesive. Check that the groove of the preset level knob aligns with the O mark on the panel.

BLOCK DIAGRAM

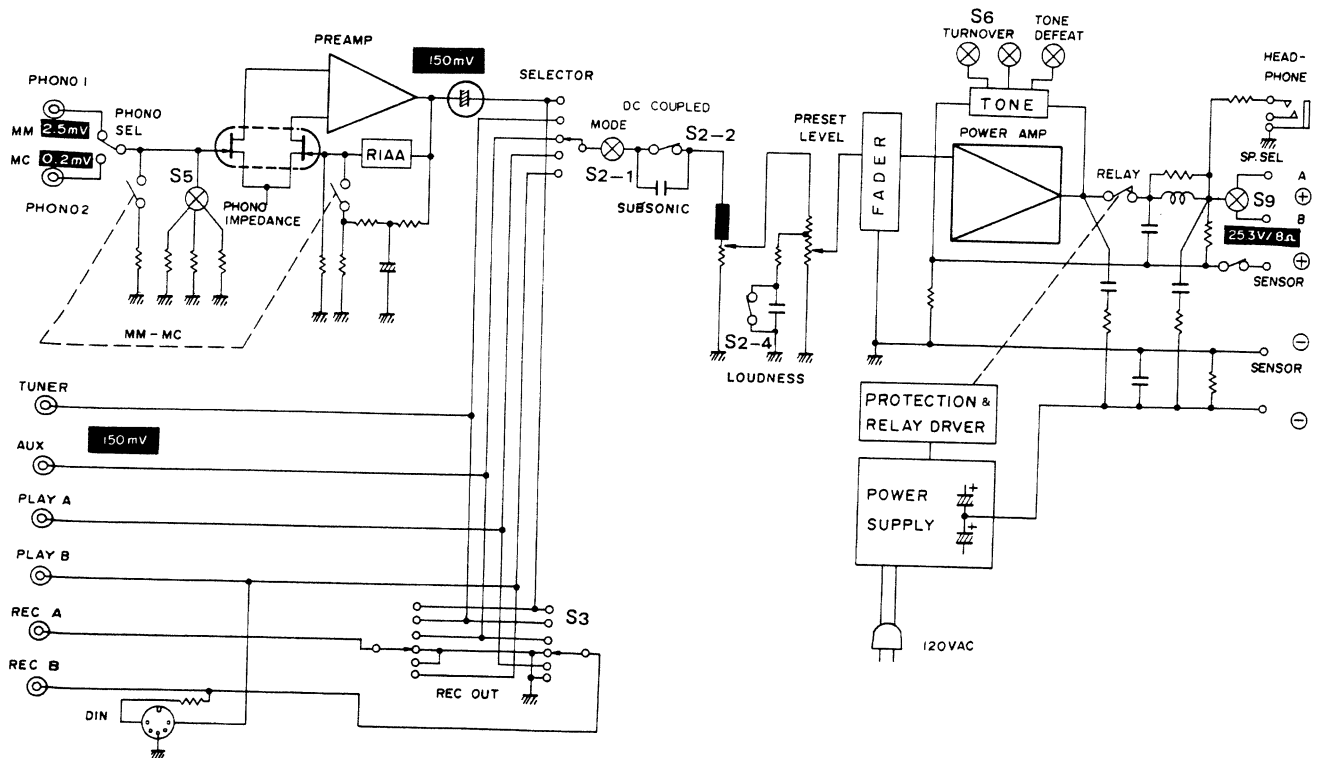

For circuit description, refer to KA-1000 Service Manual.

DISASSEMBLY FOR REPLACEMENT

- 1 Remove side plate, top plate, panel and the front glass.
- 2 Remove FADER button and FADER lamp. Now, you can remove the FADER switch (S5) pc board by spreading the claws outward and pushing the switch from the front

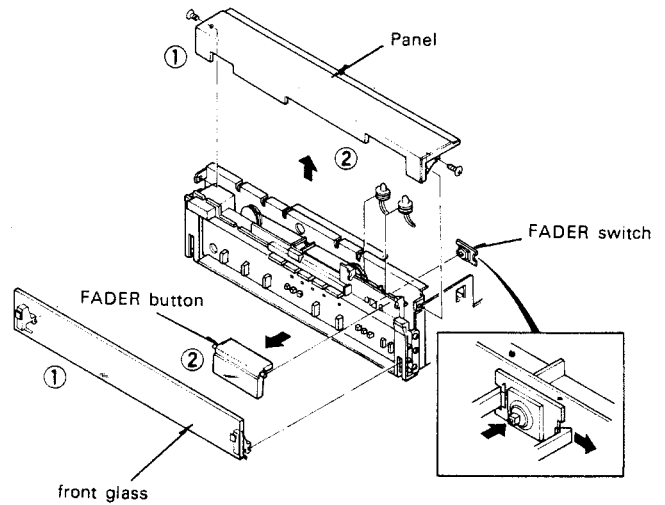

- 3 Remove the power switch button and knobs for BASS, TREBLE, BALANCE etc. by pulling them toward yourself. If they cannot be removed by hand, wind a covered wire around the shaft and pull.
- 4 Remove screws of the power switch. Remove screws at the side of the hinge and pull it to the direction of the arrow as shown. This hinge serves as a rivet to hold dress panel (A) to the chassis. For this reason, **please proceed after you remove this hinge.**
- 5 Preset level knob can be removed after the adhesive is taken off and slid to the left.

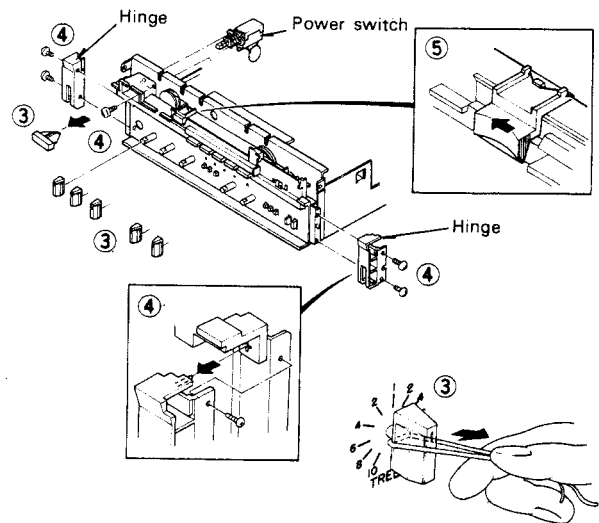

- 6 Remove dress panel (A) by pinching the claws inward and pushing it toward the front. Now, INPUT selector button can be removed.
- 7 Remove 5 screws at the front side of the bottom plate, also 2 screws at sides of dress panel ass'y and pull frontward. Now LED pc board for INPUT selector can be removed.

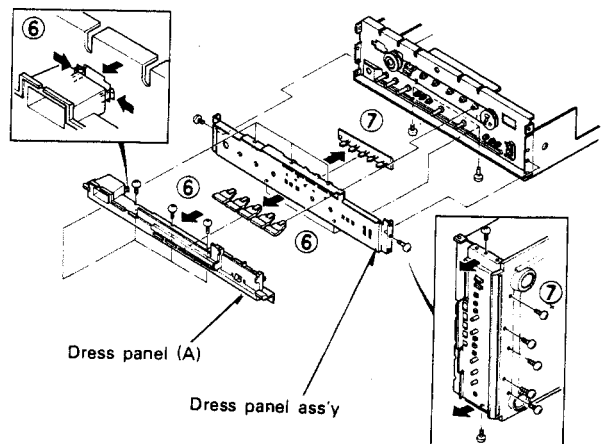

ADJUSTMENT/REGLAGES/ABGLEICH

ADJUSTMENT

OFFSET AND IDLE CURRENT

— Before adjustments —

This adjustment must be done without dummy load connected.

1. Remove top cover.
2. This amplifier uses heat pipe. For this reason, amplifier must be kept horizontal for accurate adjustment.
3. Before turning the power ON, turn potentiometers VR7 and 8 fully counterclockwise.
4. Set preset level to 0.
5. Follow steps 6 through 10 within 1 minute, after you turn the power ON.

— Adjustment —

6. Connect a DC voltmeter between TP1 and 3 (TP2 and 4 for right channel) of preamp unit (X08-185*-**).
7. Adjust VR1 (VR2) for a 0V reading of the DC voltmeter (PREAMP OFFSET).
8. Connect a DC voltmeter to speaker terminals.
9. Set the SPEAKERS switch to A+B and the PRESET LEVEL to 0.
10. Adjust CENTER ADJ VR5 (VR6) for 0V reading of the DC voltmeter (OFFSET).
11. Connect a DC voltmeter between TP25 and 23 (TP26 and 24) of audio amp unit (X09-160*-**).
12. After 2 minutes adjust IDLE ADJ VR7 (VR8) for 2 ~ 3 mV reading of the DC voltmeter (IDLE CURRENT).
13. Leave the power switch ON for 10 minutes.
14. Check that OFFSET voltages are 0V and voltage between TP25 and 23 (TP26 and 24) is now 4 ~ 5 mV.
15. If necessary, adjust each potentiometers again.
16. Place top cover.
17. After performing these adjustments IDLE current of 30 mA will flow.

REGLAGES

DECALAGE ET COURANT DE POLARISATION

— Avant les réglages —

Ce réglage sera effectué sans connecter l'antenne artificielle.

1. Retirer le couvercle du haut.
2. Cet amplificateur est équipé d'un caloduc. Il faudra donc maintenir l'amplificateur à l'horizontale pour obtenir un réglage précis.
3. Avant avoir placé l'appareil sous tension, tourner les potentiomètres VR7 et 8 à fond dans le sens inversé de celui des aiguilles d'une montre.
4. Régler PRESET LEVEL au 0.
5. Procéder aux opérations 6 à 10 dans 1 minute, après avoir placé l'appareil sous tension.

— Réglage —

6. Brancher un voltmètre de C.C. entre TP1 et 3 (TP2 et 4 pour le canal de droite) du bloc préamplificateur (X08-185* **).
7. Régler VR1 (VR2) de façon à ce que le voltmètre de C.C. indique 0V (OFFSET).
8. Brancher un voltmètre de C.C. aux bornes du haut-parleur.
9. Régler SPEAKERS interrupteur au A+B et PRESET LEVEL à 0.
10. Régler CENTER ADJ. VR5 (VR6) de façon à ce que le voltmètre de C.C. indique 0V. (OFFSET).
11. Brancher un voltmètre de C.C. entre TP25 et 23 (TP26 et 24) du bloc amplificateur audio (X09-160*-**).
12. Après 2 minutes, régler IDLE ADJ VR7 (VR8) de façon à ce que le voltmètre de C.C. indique 2 ~ 3 mV (COURANT DE POLARISATION).
13. Maintenir le commutateur d'alimentation en position de marche pendant 10 minutes.
14. Vérifier que les voltages correspondent à 0V et s'assurer que le voltage entre TP25 et 23 correspond maintenant à 4~5 mV.
15. Si cela s'avère nécessaire, procéder à nouveau au réglage de chaque potentiomètre.
16. Placer le couvercle de haut.
17. A la suite de ces divers réglages, le passage du courant de polarisation de 30 mV sera assuré.

ADJUSTMENT/REGLAGES/ABGLEICH

ABGLEICH

VERSCHIEBUNG UND LEERLAUFSTROM

— Vor die Abgleich —

Dieser Abgleich wird ohne die künstliche Antenne anzuschließen ausgeführt.

1. Die obere Abdeckung entfernen.
2. Dieser Verstärker ist mit einem Wärmerohr ausgestattet. Aus diesem Grund soll er in horizontaler Lage bleiben um eine genaue Einstellung zu ermöglichen.
3. Vor Einschalten das Potentiometers VR7 und 8 drehen voll gegen den Uhrzeigersinn.
4. Den PRESEL LEVEL Knopf auf 0.
5. Nach Einschalten die Schritte b6 bis 10 binnen 1 Minuten ausführen.

— Abgleich —

6. Einen Gleichspannungsmesser zwischen TP1 und 3 (TP2 und 4 für den rechten Kanal) des Vorverstärkers (X08-185*.***) anschließen.
7. Den VR1 (VR2) so regulieren, daß die Gleichspannungsmesser-Ablesung 0V ist. (VERSCHIEBUNG).
8. Einen Gleichspannungsmesser an die Lautsprecherklemmen anschließen.
9. Den Schalter SPEAKERS auf A+B und den PRESET VOLUME auf 0 einstellen.
10. Den CENTER ADJ. VR5 (VR6) so regulieren, daß die Gleichspannungsmesser-Ablesung 0V ist. (VERSCHIEBUNG).
11. Einen Gleichspannungsmesser zwischen TP25 und 23 (TP26 und 24) des Tonverstärker (X09-160*.***) anschließen.
12. Nach 2 Minuten, den IDLE ADJ VR7 (VR8) so regulieren, daß die Gleichspannungsmesser-Ablesung 2 ~ 3 mV ist. (LEERLAUFSTROM).
13. Den Netzschalter 10 Minuten lang eingeschaltet lassen.
14. Nachprüfen, ob die Verschiebespannungen 0V sind und die Spannung zwischen TP25 und 23 jetzt 4~5 mV beträgt.
15. Die Potentiometer erforderlichenfalls nochmals entsprechend einstellen.
16. Den oberen Deckel anbringen.
17. Nach diesen Einstellungen fließt ein Ruhestrom von 30 mV.

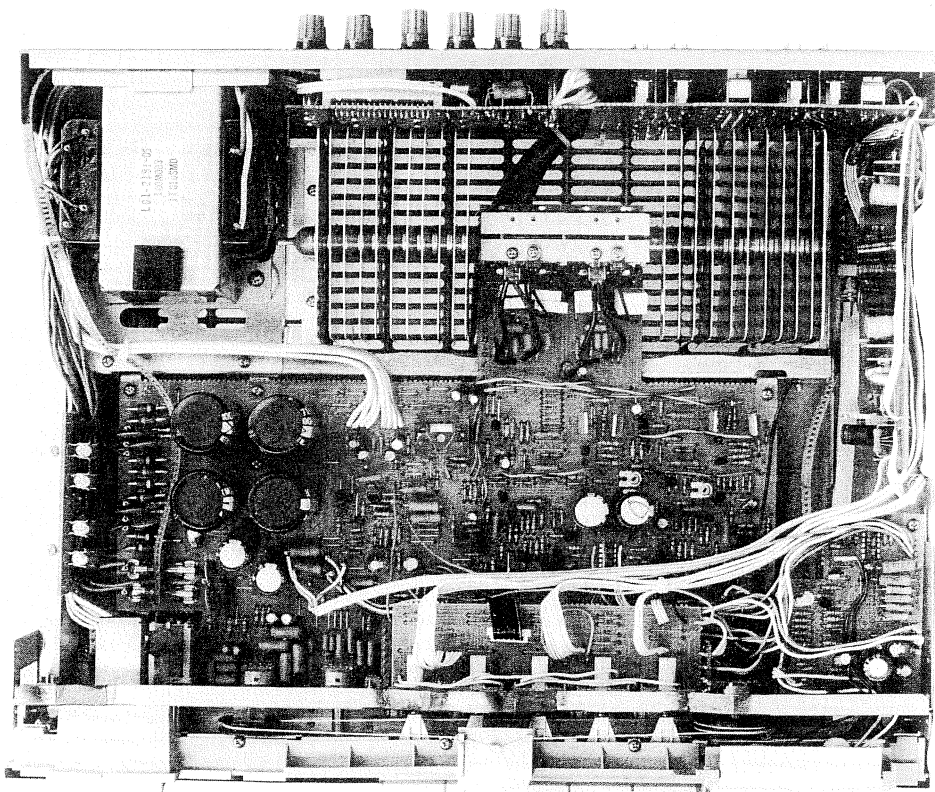

PREAMP	AUDIO AMP	
	L	R
TP3 TP1 VR1 (OFFSET)		
	TP25 TP23	TP26 TP24
TP2 VR2 TP4 (OFFSET)		
	VR7 (IDLE)	VR8 (IDLE)
	VR5 (OFFSET)	VR6 (OFFSET)

PC BOARD

PREAMP
(X08-1850-10)
Component Side View

SUB
(X13-3020-10)
Component Side View

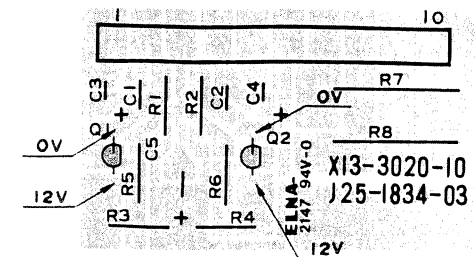
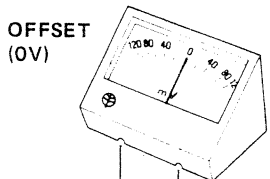
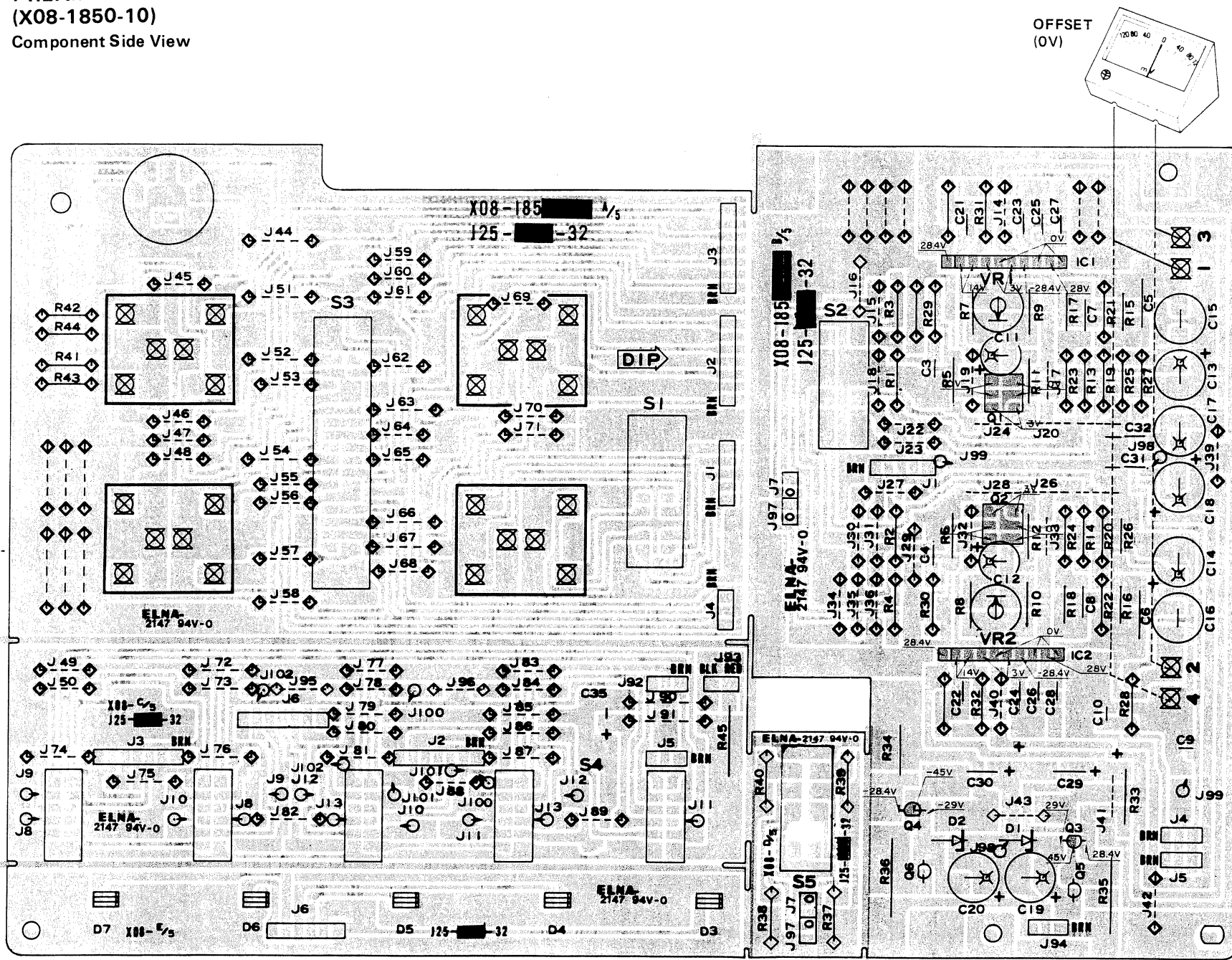

Refer to the schematic diagram for the values of resistors and capacitors.

PC BOARD

AUDIO AMP (X09-160*-.**) Component Side View

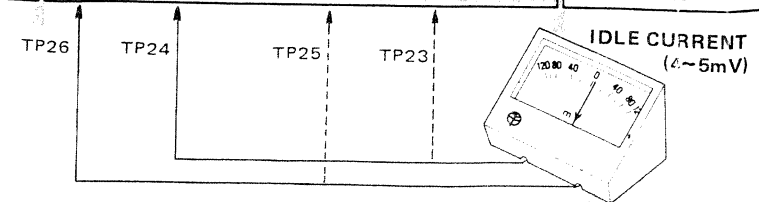
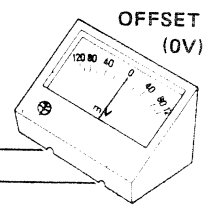
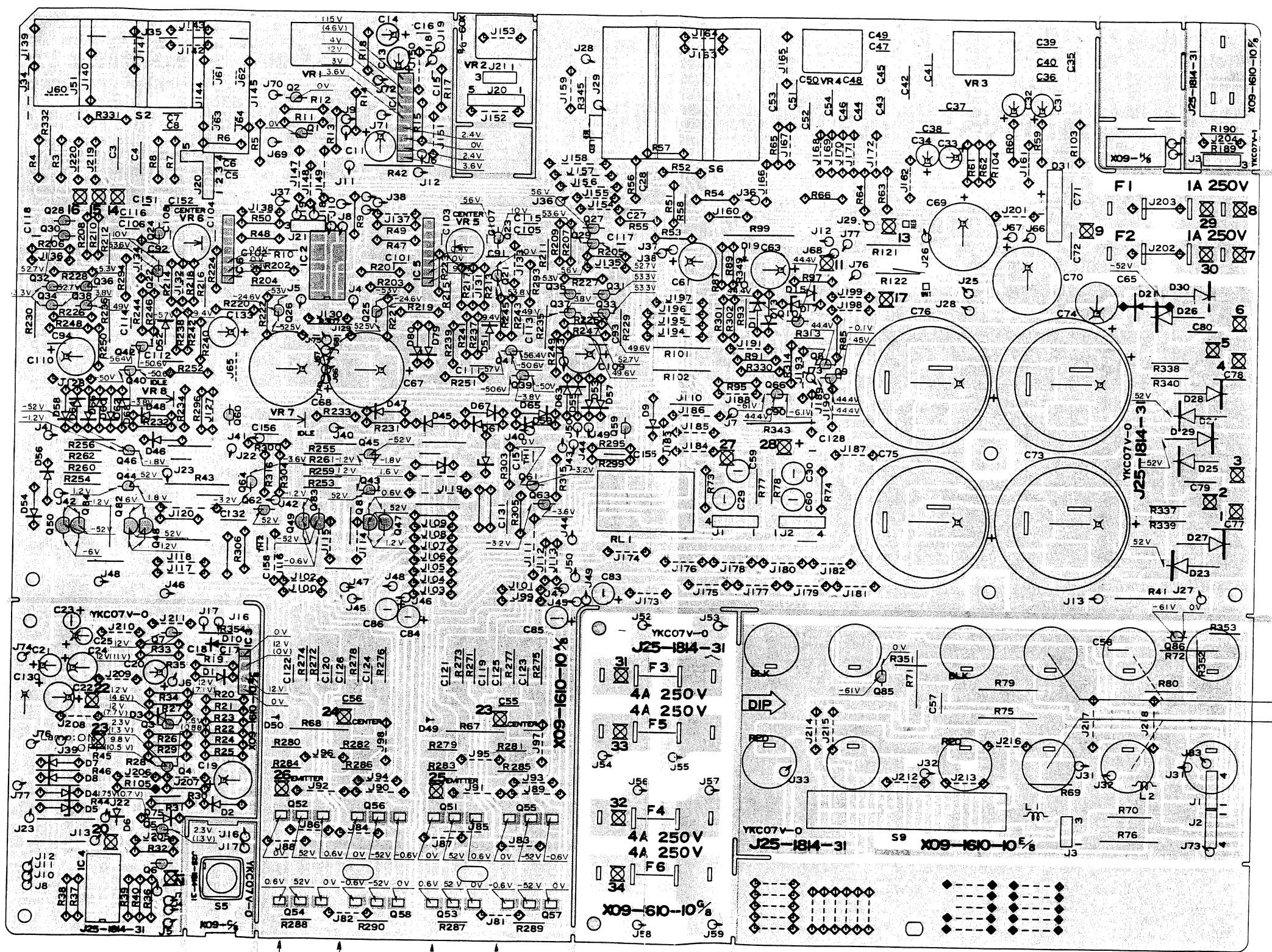

Refer to the schematic diagram for the values of resistors and capacitors.

- 2SA872
- 2SA912
- 2SA954
- 2SA992
- 2SA999
- 2SA1123
- 2SA1127NC
- 2SC535
- 2SC945
- 2SC1674
- 2SC1775
- 2SC1845
- 2SC1885
- 2SC1923
- 2SC2320
- 2SC2631

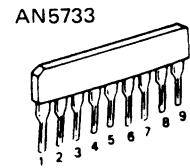

- MB84066B
- MB84069B
- μ PD4066C
- μ PD4069C

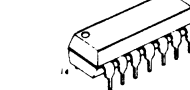

- TA2010
- TA2010A

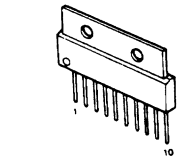

- DN819

- 2SA957
- 2SC2167

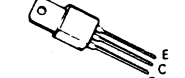

- 2SA985A
- 2SA1111
- 2SB724
- 2SC2275A
- 2SC2591
- 2SD762

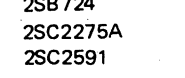

- 2SA1186
- 2SC2837

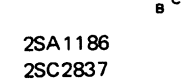

- 2SK105
- 2SK117
- 2SK163
- 2SK136

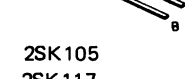

- μ PA68H



- 2SK240

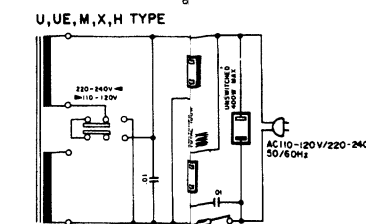
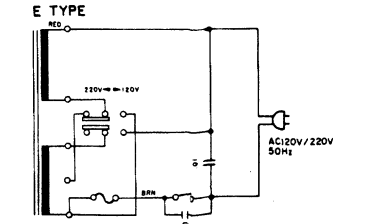
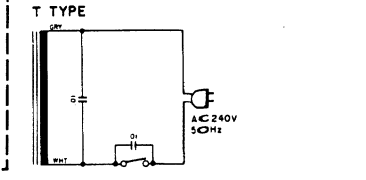
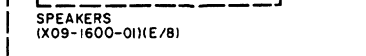
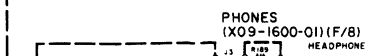
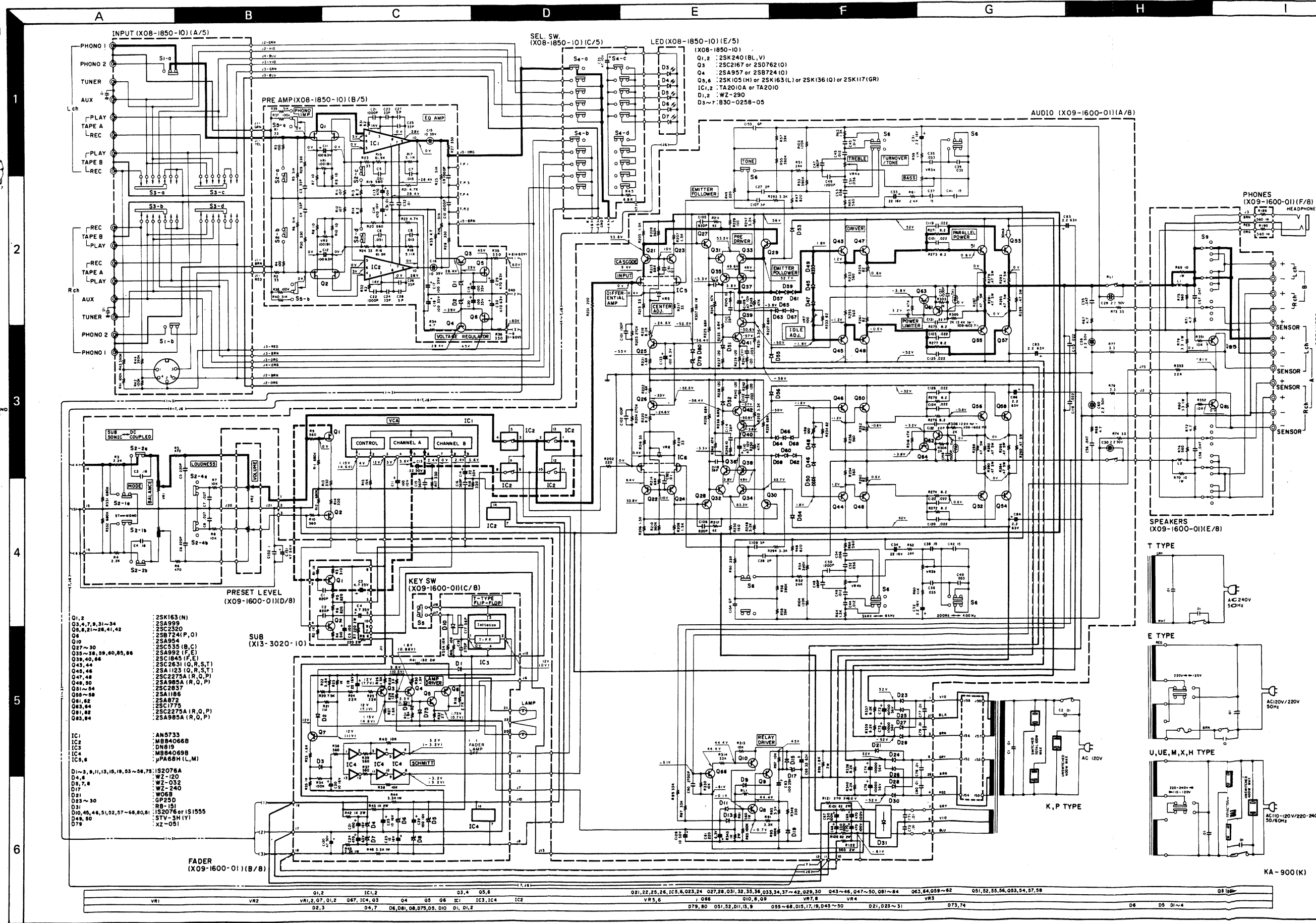

- Q1, 2 : 2SK163(N)
- Q3, 4, 7, 9, 31~34 : 2SA999
- Q8, 8, 21~26, 41, 42 : 2SC2320
- Q6 : 2SB724(P, O)
- Q5 : 2SA954
- Q27~30 : 2SC535(B, C)
- Q35~38, 59, 60, 85, 86 : 2SA992(F, E)
- Q39, 40, 46 : 2SC1845(F, E)
- Q43, 44 : 2SC2631(O, R, S, T)
- Q45, 46 : 2SA1123(O, R, S, T)
- Q47, 48 : 2SC2275A(R, O, P)
- Q48, 50 : 2SA985A(R, O, P)
- Q51~54 : 2SC2837
- Q56~58 : 2SA1186
- Q61, 62 : 2SA872
- Q63, 64 : 2SC1775
- Q61, 62 : 2SC2275A(R, O, P)
- Q63, 64 : 2SA985A(R, O, P)
- IC1 : AN5733
- IC2 : MB84066B
- IC3 : DN819
- IC4 : MB84069B
- IC5, 6 : μ PA68H(L, M)
- D1~3, 9, 11, 13, 15, 19, 53~56, 75 : IS2076A
- D4, 6 : WZ-120
- D8, 7, 8 : WZ-032
- D17 : WZ-240
- D21 : W06B
- D23~30 : GP25D
- D31 : RB-181
- D10, 45, 46, 51, 52, 57~68, 81 : IS2076 or IS1555
- D48, 50 : STV-3H(Y)
- D79 : XZ-051

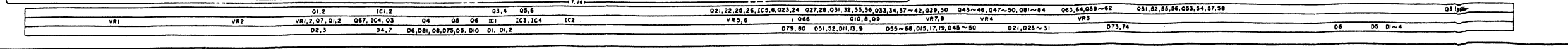

NEW HIGH SPEED INTEGRATED AMPLIFIER

KA-900

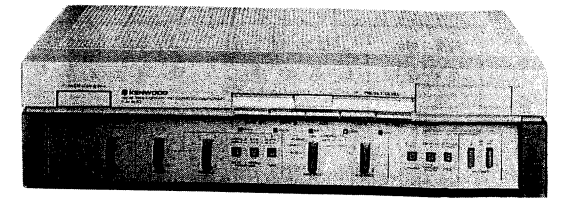

SPECIFICATIONS

PERFORMANCE

Power output
80 watts* per channel minimum RMS, both channels driven, at 8 ohms from 20 Hz to 20,000 Hz with no more than 0.005% total harmonic distortion.

Both Channels Driven..... 85 + 85 watts 8 ohms at 1,000 Hz
 Total Harmonic Distortion (20 Hz to 20,000 Hz)
 AUX input to SPEAKER output..... 0.005% at rated power into 8 ohms
 0.005% at 1/2 rated power into 8 ohms

PHONO input to SPEAKER output..... 0.007% at rated power with VOLUME - 20 dB

Intermodulation Distortion..... 0.005% at rated power into 8 ohms (80 Hz: 7 kHz = 4:1)

Damping Factor..... 500, at 100 Hz

Transient Response

Rise Time..... 0.9 μ s

Slew Rate..... ± 120 V/ μ s

Frequency Response

(DC COUPLED at ON)..... DC to 400 kHz, -3 dB

(DC COUPLED at OFF)..... 18 Hz to 400 kHz, -3 dB

Speaker Impedance..... Accept 4 ohms to 16 ohms

Input Sensitivity/Impedance

Phono (MM)..... 2.5 mV/33 k ohms, 47k ohms and 100 k ohms

Phono (MC)..... 0.2 mV/100 ohms

Tuner, AUX, Tape A, B..... 150 mV/47 k ohms

Signal-to-Noise Ratio (IHF, A)

Phono (MM)..... 86 dB for 2.5 mV input
 92 dB for 5.0 mV input
 98 dB for 10 mV input

Phono (MC)..... 66 dB for 0.2 mV input
 72 dB for 0.4 mV input

Tuner, AUX, Tape A, B..... 105 dB for 150 mV input

Maximum Input Level

Phono (MM)..... 270 mV (RMS), T.H.D. 0.003% at 1,000 Hz

Phono (MC)..... 15 mV (RMS), T.H.D. 0.003% at 1,000 Hz

Output Level/Impedance

Tape REC (Pin)..... 150 mV/330 ohms

(DIN)..... 30 mV/80 k ohms

Phono Frequency Response..... RIAA standard curve ± 1.2 dB (20 Hz to 20,000 Hz)

Tone Control

Bass Turnover Freq. 200 Hz..... ± 10 dB at 50 Hz

400 Hz..... ± 10 dB at 100 Hz

Treble Turnover Freq. 3 kHz..... ± 10 dB at 10 kHz

6 kHz..... ± 10 dB at 20 kHz

Loudness Control..... +10 dB at 100 Hz (at -30 dB VOLUME Level)

Subsonic Filter..... 18 Hz, 6 dB/oct

GENERAL

Power Requirements..... 60 Hz 120 V (U.S.A. & Canada Model)

or 50/60 Hz 110-120 V/20-240 V

Power Consumption..... 4 A (UL and CSA)

480 W (IEC)

A.C. Outlet..... Switched 2, Unswitched 1

Dimensions..... W 440 mm (17-5/16")

H 123 mm (4-7/32")

D 375 mm (14-3/4")

Weight (Net)..... 10.0 kg (22.0 lbs)

* Measured pursuant to Federal Trade Commission's Trade Regulation rule on Power Output Claims for Amplifier in U.S.A.

Kenwood follows a policy of continuous advancements in development. For this reason specifications may be changed without notice.

Kenwood poursuit une politique de progrès constants en ce qui concerne le développement. Pour cette raison, les spécifications sont sujettes à modifications sans préavis.

Kenwood strebt ständige Verbesserungen in der Entwicklung an. Jederzeit bleiben Änderungen der technischen Daten vorbehalten.

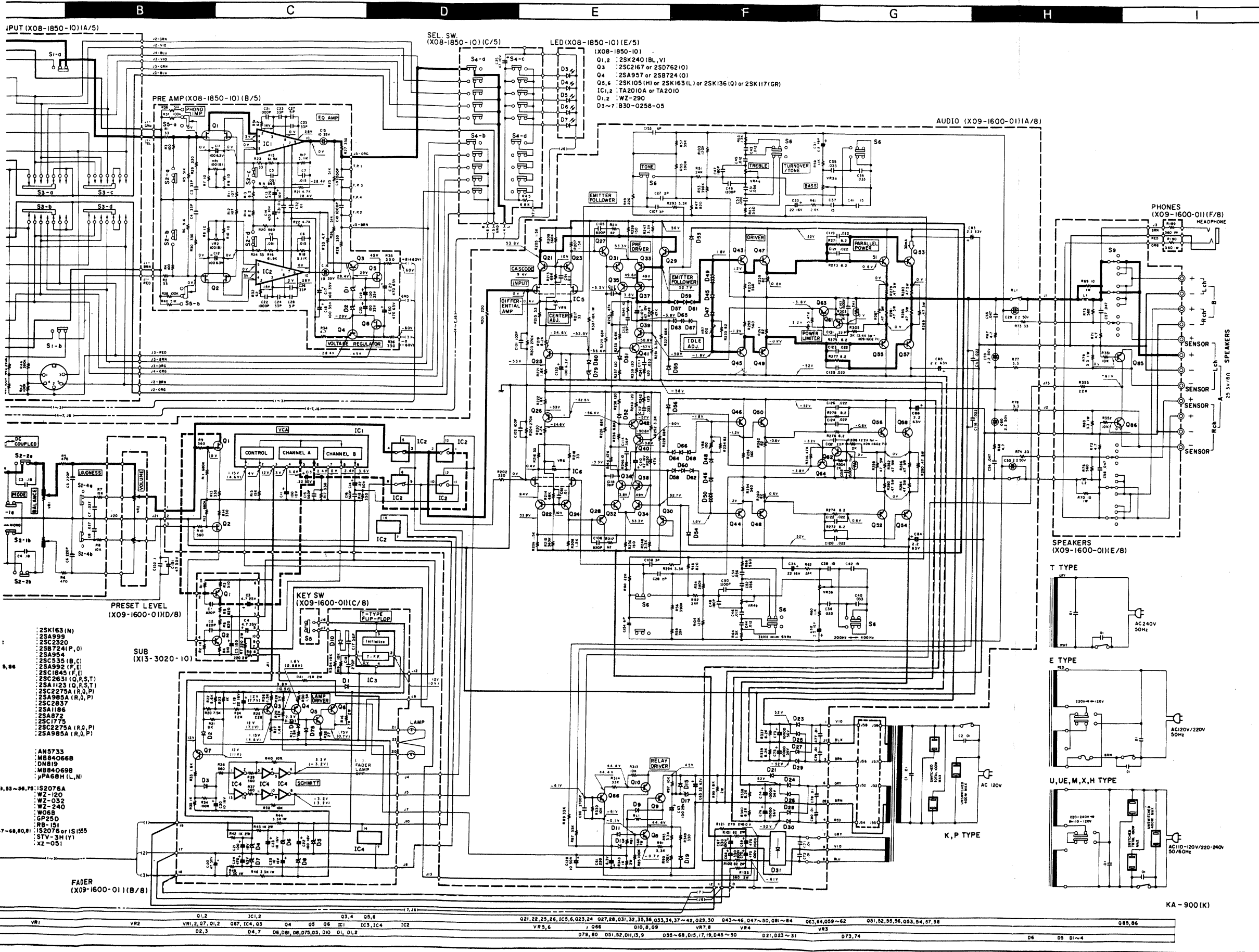

PARTS LIST

INSTRUCTION FOR PARTS LIST

Ref. No. 参照番号	Parts No. 部品番号	Description 部品名/規格	Re- marks 備考
②			
①	1 3A	MAIN CHASSIS ASS'Y	
	2 2A	FRONT CHASSIS	
	3 2A	FLUOR DISPLAY HOLDER	
	4 1A,1B	FRONT PANEL	
	5 1A	FRONT PANEL ASS'Y	③
⑤	PS3	PUSH SW.(SELECTOR) 111	
	RS1	ROTARY SW.(FUNC.) 105	
	RL1	RELAY FIG.104	①

- ① Exploded view drawing No.
 ② Position in exploded view.
 ③ Symbol of new parts
 ④ Area to which parts are shipped. Example: A20-1390-13 is the part No. of FRONT PANEL ASS'Y for the "K" type products (for U.S.A.). When this column is blank, it means that the same type of parts (same parts No.) are used for the products shipped to all areas.
 ⑤ Reference No. in schematic diagram.
 ⑥ Abbreviation of "ceramic capacitor"
 All capacitors and resistors are listed using abbreviations.
 Abbreviations
 * Abbreviations of capacitors (Parts No. with initial letter "C")
 ELECTRO Electrolytic capacitor
 LL-ELEC Low leak electrolytic capacitor
 NP-ELEC Non-pole electrolytic capacitor
 MICA Mica capacitor
 POLYSTY Polystyrene capacitor
 MYLAR Mylar capacitor
 CERAMIC Ceramic capacitor
 TANTAL Tantalum capacitor
 MF Metallized film capacitor
 MP Metallized paper capacitor
 OIL Oil capacitor
 The unit "UF" is used in lieu of "μF"
 * Abbreviations of resistors (Parts No. with initial letters "R")
 RC Carbon composition resistor
 RD Carbon film resistor
 FL-PROOF RD Flame-proof carbon film resistor
 RW Wire wound power resistor
 FL-PROOF RS Flame-proof metal oxide film resistor
 RN Metal film resistor
 FUSE-RESIST Resistor with fuse function
 2B Rated wattage 1/8W
 2E Rated wattage 1/4W
 2H Rated wattage 1/2W
 3A Rated wattage 1W
 3D Rated wattage 2W
 3F Rated wattage 3W
 3G Rated wattage 4W
 3H Rated wattage 5W
 All resistor values are indicated with the unit (Ω) omitted.
 * Abbreviations common to capacitors and resistors.
 C ±0.25pF (Used for capacitors only)
 D ±0.5pF (Used for capacitors only)
 F ±1%
 G ±2%
 J ±5%
 K ±10%
 M ±20%
 Z +80%, -20% (Used for capacitors only)
 P +100%, -0% (Used for capacitors only)
 Resistors RD (carbon composition resistors) are not listed in the parts list. For values, refer to the schematic diagram.
 * Codes in X09-160**
 K : X09-1600-10
 U : X09-1600-81
 E : X09-1602-71

Ref. No. 参照番号	Parts No. 部品番号	Description 部品名/規格	Re- marks 備考
KA-900 UNIT			
1	2A	METALLIC FRAME (L)	
2	2A,3B	METALLIC FRAME (H)	
3	2B	METALLIC FRAME (C)	
4	3B	SUB PANEL	
5	1B	REAR PANEL	
6	1A	MOUNT, HARD.(PWR TRANS)	
7	2A	MOUNT, HARD.(FUSE PCB)	
-	041-0401-15	SIGMA CORD	
19	2A	FRONT PANEL	*K
19	2A	FRONT PANEL	PU
19	2A	FRONT PANEL	MH
19	2A	FRONT PANEL	UE
19	2A	FRONT PANEL	XE
19	2A	FRONT PANEL	*T
20	3A	DRESSING PANEL (A)	
21	3A	DRESSING PANEL (B) ASSY	*
22	1A	BOTTOM PLATE	
23	1A	SIDE PLATE (L)	
24	1A	SIDE PLATE (R)	
25	1A	TOP PLATE	
-	B46-0055-30	WARRANTY CARD	P
-	B46-0060-00	WARRANTY CARD	T
-	B46-0061-30	WARRANTY CARD	K
-	B46-0062-30	WARRANTY CARD	UH
-	B46-0062-30	WARRANTY CARD	UE
-	B46-0063-13	WARRANTY CARD	UH
-	B46-0063-13	WARRANTY CARD	UE
-	B46-0064-20	WARRANTY CARD	X
-	B50-3245-00	INSTRUCTION MANUAL	*K
-	B50-3246-00	INSTRUCTION MANUAL	*P
-	B50-3246-00	INSTRUCTION MANUAL	M
-	B50-3247-00	INSTRUCTION MANUAL	*P
-	B50-3247-00	INSTRUCTION MANUAL	UH
-	B50-3247-00	INSTRUCTION MANUAL	HX
-	B50-3247-00	INSTRUCTION MANUAL	UE
-	B50-3248-00	INSTRUCTION MANUAL	*M
-	B50-3249-00	INSTRUCTION MANUAL	*E
-	B50-3263-00	INSTRUCTION MANUAL	*T
-	B59-0018-00	SERVICE STATIONS' LIST	UH
-	B59-0018-00	SERVICE STATIONS' LIST	UE
26	3A	FADER BUTTON	
27	3A	FRONT GLASS	
29	3A	LAMP (FADER) 8V 0.075A	
-	C91-0023-05	CERAMIC 0.01UF AC250V	UH
-	C91-0023-05	CERAMIC 0.01UF AC250V	HX
-	C91-0023-05	CERAMIC 0.01UF AC250V	UE
-	C91-0079-05	CERAMIC 0.01UF AC125V	KP
-	C91-0079-05	CERAMIC 0.01UF AC125V	TE
30	3A	PULLEY (SMALL)	
31	3B	PULLEY (LARGE)	
32	1B	AC OUTLET	KP
32	1B	AC OUTLET	UM
32	1B	AC OUTLET	HX
32	1B	AC OUTLET	UE
34	1B	POWER CORD	KP
34	1B	POWER CORD	E
34	1B	POWER CORD	UM
34	1B	POWER CORD	H

Ref. No. 参照番号	Parts No. 部品番号	Description 部品名/規格	Re- marks 備考
34	1B	E30-0515-05 POWER CORD	UE
34	1B	E30-0587-05 POWER CORD	T
34	1B	E30-0649-05 POWER CORD	X
35	1A	F01-0357-15 HEAT SINK ASSY	*
-	H01-3227-04	CARTON BOX	*U
-	H01-3227-04	CARTON BOX	MH
-	H01-3227-04	CARTON BOX	UE
-	H01-3227-04	CARTON BOX	X
-	H01-3229-04	CARTON BOX	*E
-	H01-3230-04	CARTON BOX	*T
-	H01-3255-04	CARTON BOX	*K
-	H10-1563-02	POLYSTYRENE FIXTURE	
-	H20-0453-04	COVER	
-	H25-0078-04	BAG	KP
-	H25-0078-04	BAG	UH
-	H25-0078-04	BAG	UE
-	H25-0078-04	BAG	XT
36	1B	J42-0083-05 BUSHING	
36	1B	J42-0083-05 BUSHING	KP
36	1B	J42-0083-05 BUSHING	UM
36	1B	J42-0083-05 BUSHING	HT
36	1B	J42-0083-05 BUSHING	UE
36	1B	J42-0083-05 BUSHING	E
36	1B	J42-0085-05 BUSHING	X
37A	3A	J50-0098-03 HINGE (L)	
37B	3A	J50-0099-03 HINGE (R)	
38	3A	J50-0100-04 HINGE (A)	
39	3B	K27-0188-04 PUSH BTN(PHONO 1-2)	*
40	3A	K27-0189-04 PUSH BTN(POWER)	
41	3A	K27-0190-14 PUSH BTN(INPUT SELECT)	
42	3B	K27-0191-03 PUSH BTN(CART MM-MC)	*
43	2B	K27-0192-14 PUSH BTN(FILTER,ETC)	
44	3B	K29-0381-33 KNOB (PRESET LEVEL)	
45	3A	K29-0382-14 KNOB (SP,TONE,BAL,REC)	
46	1A	L01-2181-05 POWER TRANSFORMER	*K
46	1A	L01-2181-05 POWER TRANSFORMER	P
46	1A	L01-2182-05 POWER TRANSFORMER	*T
46	1A	L01-2185-05 POWER TRANSFORMER	*U
46	1A	L01-2185-05 POWER TRANSFORMER	MH
46	1A	L01-2185-05 POWER TRANSFORMER	UE
46	1A	L01-2185-05 POWER TRANSFORMER	X
46	1A	L01-2186-05 POWER TRANSFORMER	*E
47	1B	N08-0128-35 GND TERMINAL	
48	3A	N09-0100-14 SCREW (PULLEY)	
49	1A	N09-0363-05 SCREW (SIDE PLATE)	
50	1B,2A	N09-0364-05 SCREW (POWER TR)	
51	3A	N14-0127-04 NUT (FRONT GLASS)	
52B	1B	S31-2050-05 SLIDE SW.(VOLTAGE SEL)	UH
52B	1B	S31-2050-05 SLIDE SW.(VOLTAGE SEL)	HX
52B	1B	S31-2050-05 SLIDE SW.(VOLTAGE SEL)	UE
52B	1B	S31-2050-05 SLIDE SW.(VOLTAGE SEL)	E
52A	2B	S40-1014-05 PUSH SWITCH (POWER)	UM
52A	2B	S40-1014-05 PUSH SWITCH (POWER)	HX
52A	2B	S40-1014-05 PUSH SWITCH (POWER)	UE
52A	2B	S40-1015-05 PUSH SWITCH (POWER)	KP
52A	2B	S40-2099-05 PUSH SWITCH (POWER)	TE
53	3B	S90-0039-05 REMOTE SWITCH	*
54	3B	S90-0051-05 REMOTE WIRE	
55	2B	S90-0041-05 REMOTE SWITCH (SP)	*
56	3B	S90-0043-05 REMOTE SWITCH (REC OUT)	

PARTS LIST

Ref. No. 参照番号	Parts No. 部品番号	Description 部品名/規格	Re- marks 備考	Ref. No. 参照番号	Parts No. 部品番号	Description 部品名/規格	Re- marks 備考
Q51 -54	V01-1186-10	2SA1186(O,Y)		C17	C71-1756-06	CERAMIC 56PF J	
Q55 -58	V03-2837-10	2SC2837(O,Y)		C18	C71-1710-02	CERAMIC 10PF D	
57 2B,3B	X08-1850-10	PRE AMP PCB ASSY	* *K P	C19	C25-1222-67	LL-ELEC 22UF 16WV	
58 2B,3B	X09-1600-10	AUDIO AMP PCB ASSY	*U	C20	C25-1210-67	LL-ELEC 10UF 16WV	
58 2B,3B	X09-1600-10	AUDIO AMP PCB ASSY	MH	C21 ,22	C25-1210-77	LL-ELEC 100UF 16WV	
58 2B,3B	X09-1600-81	AUDIO AMP PCB ASSY	UE	C24	C24-0847-77	ELECTRO 470UF 6,3WV	
58 2B,3B	X09-1600-81	AUDIO AMP PCB ASSY	X	C25	C25-1210-67	LL-ELEC 10UF 16WV	
58 2B,3B	X09-1602-71	AUDIO AMP PCB ASSY	*T	C27 ,28	C71-1702-01	CERAMIC 2PF C	
58 2B,3B	X09-1602-71	AUDIO AMP PCB ASSY	E	C29 ,30	C26-1722-57	NP-ELEC 2,2UF 50WV	
59 2B	X13-3020-10	SUB PCB ASSY		C31 ,32	C25-1722-57	LL-ELEC 2,2UF 50WV	
PRE AMP (X08-1850-10)							
D3 -7	B30-0258-05	LED		C33 ,34	C25-1222-67	LL-ELEC 22UF 16WV	
C1 ,2	C52-1756-16	CERAMIC 560PF K		C35 ,36	C45-1733-35	MYLAR 0,033UF K	
C3 ,4	C71-1712-16	CERAMIC 120PF J		C37 ,38	C46-1715-46	MYLAR 0,15UF K	
C5 ,6	C49-2051-34	MYLAR 0,051UF G		C39 ,40	C45-1733-35	MYLAR 0,033UF K	
C7 ,8	C49-2015-35	MYLAR 0,015UF J		C41 ,42	C46-1715-46	MYLAR 0,15UF K	
C9 ,10	C48-1710-25	POLYSTY 1000PF J		C43 -46	C46-1712-35	MYLAR 0,012UF J	
C11 ,12	C90-0402-05	ELECTRO 100UF 6,3WV		C47 ,48	C71-1712-16	CERAMIC 180PF K	
C13 ,14	C90-0532-05	ELECTRO 470UF 10WV		C49 ,50	C46-1712-26	MYLAR 0,0012UF K	
C15 ,16	C90-0404-05	NP-ELEC 10UF 35WV		C51 -54	C46-1756-35	MYLAR 0,056UF J	
C17 -20	C24-6510-71	ELECTRO 100UF 35WV		C55 -58	C46-1747-35	MYLAR 0,047UF J	
C21 ,22	C91-0100-05	POLYSTY 1000PF J		C59 ,60	C26-1722-57	NP-ELEC 2,2UF 50WV	
C23 -26	C71-1733-06	CERAMIC 33PF K		C61	C24-0822-79	ELECTRO 220UF 6,3WV	
C27 ,28	C71-1705-01	CERAMIC 5PF C		C63	C24-1410-71	ELECTRO 100UF 25WV	
C29 ,30	C24-1847-71	ELECTRO 470UF 63WV		C65	C24-1833-61	ELECTRO 33UF 63WV	
C31 ,32	C49-2010-34	MYLAR 0,01UF G		C67 ,68	C24-2033-77	ELECTRO 330UF 100WV	
C33 ,34	C55-1710-38	CERAMIC 0,01UF Z		C69 ,70	C24-2047-77	ELECTRO 470UF 100WV	
C35	C24-1047-60	ELECTRO 47UF 10WV		C71 ,72	C54-2710-39	CERAMIC 0,01UF P	
201 1B	E06-0510-05	DIN CONNECTOR		C73 -76	C90-0492-05	ELECTRO 10000UF 56V	
202 1B	E13-0429-05	PHONO JACK		C77 -80	C54-2710-39	CERAMIC 0,01UF P	
R11 ,12	R48-2107-03	RN 107 F 2E		C93 -86	C24-1822-51	ELECTRO 2,2UF 63WV	
R13 ,14	R48-6282-95	RN 8,2 J 2E		C90	C46-1727-25	MYLAR 0,0027UF K	
R15 ,16	R48-2619-23	RN 61,9K F 2E		C90	C52-1715-26	CERAMIC 0,0015UF K	
R17 ,18	R48-2511-13	RN 5,11K F 2E		C91 ,92	C46-1710-35	MYLAR 0,01UF J	
R23 ,24	R48-6233-05	RN 33 J 2E		C101,102	C71-1710-15	CERAMIC 100PF J	
R33 ,34	R43-1247-95	FL-PROOF RD4,7 J 2E		C105,106	C52-1782-16	CERAMIC 820PF K	
R35 ,36	R47-5533-15	FL-PROOF RS330 J 3D		C107,108	C71-1702-01	CERAMIC 2PF C	
R45	R47-5456-25	FL-PROOF RS5,6K J 3A		C109,110	C24-1047-69	ELECTRO 47UF 10WV	
VR1 ,2	R12-0502-05	TRIMMING POT, 100KB		C111,112	C45-1733-35	MYLAR 0,033UF K	
S1	S90-0045-05	SLIDE SW.(PHONE 1-2)	*	C113,114	C71-1739-06	CERAMIC 39PF J	
S2	S40-4033-05	PUSH SW.(MM-MC)		C115,116	C55-1722-38	CERAMIC 0,022UF Z	
S3	S90-0038-05	SLIDE SW.(REC-OUT)		C117,118	C71-1710-02	CERAMIC 10PF D	
S4	S42-5020-05	PUSH SW.(INPUT SEL)		C119-126	C46-1722-35	MYLAR 0,022UF J	
S5	S31-2059-05	SLIDE SW.(PHONE IMP)		C128	C25-1710-67	LL-ELEC 10UF 50WV	
D1 ,2	V11-4109-20	WZ-290		C130	C24-1747-61	ELECTRO 47UF 50WV	
IC1 ,2	V30-0520-10	TA2010A	*	C133	C24-0810-79	ELECTRO 100UF 6,3WV	
Q1 ,2	V09-0153-10	2SK240(BL,V)	*	C151	C25-1747-47	LL-ELEC 0,47UF 50WV	
Q3	V03-2167-10	2SC2167(Y,G)	*	C152	C46-1710-45	MYLAR 0,1UF J	
Q4	V01-0957-10	2SA957(Y,G)	*	C153,154	C71-1706-02	CERAMIC 6PF D	
Q5 ,6	V09-0127-50	2SK105(H)	*	C155,156	C71-1722-15	CERAMIC 220PF J	
AUDIO AMP (X09-1610*-**)							
C3 ,4	C46-1718-46	MYLAR 0,18UF K		C157,158	C52-1715-26	CERAMIC 0,0015UF K	
C5 ,6	C71-1722-15	CERAMIC 220PF J		301 2B	E11-0081-05	PHONE JACK	K
C7 ,8	C46-1727-35	MYLAR 0,027UF J		302 1B	F20-0814-05	SPEAKER TERMINAL BOARD	K
C11	C24-1010-79	ELECTRO 100UF 10WV		F1 ,2	F05-1021-05	FUSE 1A 250V	K
C13 ,14	C25-1722-47	LL-ELEC 0,22UF 50WV		F1 ,2	F05-1023-05	FUSE 1A 250V	K
C15 ,16	C52-1756-16	CERAMIC 560PF K		F1 ,2	F06-1021-05	FUSE 1A 250V	K
				F3 -6	F05-4021-05	FUSE 4A 250V	K
				F3 -6	F05-4022-05	FUSE 4A 250V	K
				F3 -6	F05-4024-05	FUSE F4A 250V	E
				-	J13-0055-05	FUSE HOLDER	
				L1 ,2	L39-0085-05	COIL	

PARTS LIST

Ref. No. 参照番号	Parts No. 部品番号	Description 部品名 / 規格	Re- marks 備考
R16	R47-5527-25	FL-PROOF RS2.7K J 3D	
R41	R47-5515-15	FL-PROOF RS150 J 3D	
R42 ,43	R47-5510-25	FL-PROOF RS1K J 3D	
R44 -46	R47-5433-25	FL-PROOF RS3.3K J 3A	
R67 ,68	R47-5547-95	FL-PROOF RS4.7 J 3D	
R69 ,70	R47-5410-05	FL-PROOF RS10 J 3A	
R71 ,72	R47-5547-95	FL-PROOF RS4.7 J 3D	
R75 ,76	R47-5556-15	FL-PROOF RS560 J 3D	
R77 ,78	R43-1233-95	FL-PROOF R03.3 J 2E	
R79 ,80	R47-5433-95	FL-PROOF RS3.3 J 3A	
R99	R47-5516-25	FL-PROOF RS1.8K J 3D	
R101,102	R47-5582-05	FL-PROOF RS92 J 3D	
R121	R47-5527-15	FL-PROOF RS270 J 3D	
R122	R47-5556-15	FL-PROOF RS560 J 3D	
R189,190	R47-5456-15	FL-PROOF RS560 J 3A	
R229,230	R43-1215-15	FL-PROOF R0150 J 2E	
R235,236	R47-5468-25	FL-PROOF RS6.8K J 3A	
R253-256	R43-1256-15	FL-PROOF R0560 J 2E	
R259-262	R43-1282-05	FL-PROOF R022 J 2E	
R271-278	R43-1282-95	FL-PROOF R02.2 J 2E	
R279-290	R92-0203-05	FIXED RESISTOR	
R307	R47-541E-35	FL-PROOF RS18K J 3A	
R337-340	R43-1282-25	FL-PROOF R08.2K J 2E	
R343	R47-5510-25	FL-PROOF RS1K J 3D	
VR1	R06-5062-05	POTENTIOMETER (BAL)	
VR2	R06-5063-05	POTENTIOMETER (VOL)	
VR3 ,4	R06-4051-05	POTENTIOMETER (TONE)	
VR5 ,6	R12-0502-05	TRIMMING POT. 100	
VR7 ,8	R12-0077-05	TRIMMING POT. 100	
RL1	S51-2045-05	RELAY	
S2	S42-3048-05	PUSH SW (FIL,MODE,LCUD)	*
S5	S40-1012-05	PUSH SWITCH (FADER)	
S6	S42-3047-05	PUSH SWITCH (TURN OVER)	*
S9	S90-0047-05	SLIDE SW (SP SELECTOR)	*
D1 -3	V11-0273-05	1S2076A	
D4	V11-4100-40	WZ-120	
D5	V11-4172-26	WZ-032	
D6	V11-4100-40	WZ-120	
D7 ,8	V11-4172-26	WZ-032	
D9	V11-0273-05	1S2076A	
D10	V11-0271-05	1S2076	
D11	V11-0273-05	1S2076A	
D13	V11-0273-05	1S2076A	
D15	V11-0273-05	1S2076A	
D17	V11-0287-05	WZ-240	
D19	V11-0273-05	1S2076A	
D21	V11-0295-05	W068	
D23 -30	V11-0465-05	GP25D	
D31	V11-5100-60	RB-151	
D45 -48	V11-0271-05	1S2076	
D49 ,50	V21-0013-05	STV-3H(Y)	
D51 ,52	V11-0271-05	1S2076	
D53 -56	V11-0273-05	1S2076A	
D57 -68	V11-0271-05	1S2076	
D75	V11-0273-05	1S2076A	
D79	V11-4103-60	XZ-051	
D80	V11-0271-05	1S2076	
IC1	V30-0514-10	AN5733	*
IC2	V30-0516-10	MB84066B	*
IC3	V30-0515-10	DN819	*
IC4	V30-0526-10	MB84069B	*
IC5 ,6	V09-0145-30	UPA66H(L,M)	

Ref. No. 参照番号	Parts No. 部品番号	Description 部品名 / 規格	Re- marks 備考
Q1 ,2	V09-0144-40	2SK163(N)	
Q3 ,4	V01-0999-10	2SA999	
Q5	V03-2320-00	2SC2320	
Q6	V02-0724-20	2SB724(P,O)	
Q7	V01-0999-10	2SA999	
Q8	V03-2320-00	2SC2320	
Q9	V01-0999-10	2SA999	
Q10	V01-0954-00	2SA954	
Q21 -26	V03-2320-00	2SC2320	
Q27 -30	V03-0098-05	2SC535 (P)	
Q31 -34	V01-1127-30	2SA1127(K)	
Q35 -38	V01-0992-10	2SA992(F,E)	
Q39 ,40	V03-1845-10	2SC1845(F,E)	
Q41 ,42	V03-2320-00	2SC2320	
Q43 ,44	V03-2631-10	2SC2631(Q,R,S)	
Q45 ,46	V01-1123-10	2SA1123(Q,R,S)	
Q47 ,48	V03-2275-10	2SC2275A(R,Q,P)	*
Q49 ,50	V01-0985-10	2SA985A	
Q59 ,60	V01-0992-10	2SA992(F,E)	
Q61 ,62	V01-0196-05	2SA672	
Q63 ,64	V03-1775-00	2SC1775	
Q66	V03-1845-10	2SC1845(F,E)	
Q85 ,86	V01-0992-10	2SA992(F,E)	
TH1 ,2	V22-0027-05	5TP-41L	
SUB (X13-3020-10)			
C1 ,2	C52-1747-26	CERAMIC 0.0047UF K	
C3 ,4	C24-1447-57	ELECTRO 4.7UF 25WV	
R7 ,8	R47-5522-15	FL-PROOF RS220 J 3D	
Q1 ,2	V01-0992-00	2SA992	

Semiconductor Substitutions

Name	Substitutions
PRE AMP (X08-1850-10)	
TA2010A	TA2010
2SA957 (Y, G)	2SB724 (O)
2SC2167	2SD762 (O)
2SK105 (H)	2SK163 (L), 2SK136 (Q), 2SK117 (GR)
AUDIO AMP (X09-1610-10)	
MB84066B	μPD4066C
MB84069B	μPD4069C
2SA985A (R, Q, P)	2SA1111 (Q, R)
2SA1123 (Q, R, S)	2SA912 (Q, R, S)
2SC535	2SC1674 (L, K), 2SC1923
2SC2275A (R, Q, P)	2SC2591 (Q, R)
2SC2320	2SC945
2SC2631 (Q, R, S)	2SC1885 (Q, R, S)
2SK163 (N)	2SK105 (H)
1S2076	1S1555
GP25D	U05C (S)

WORLD MAP & AREA CODE

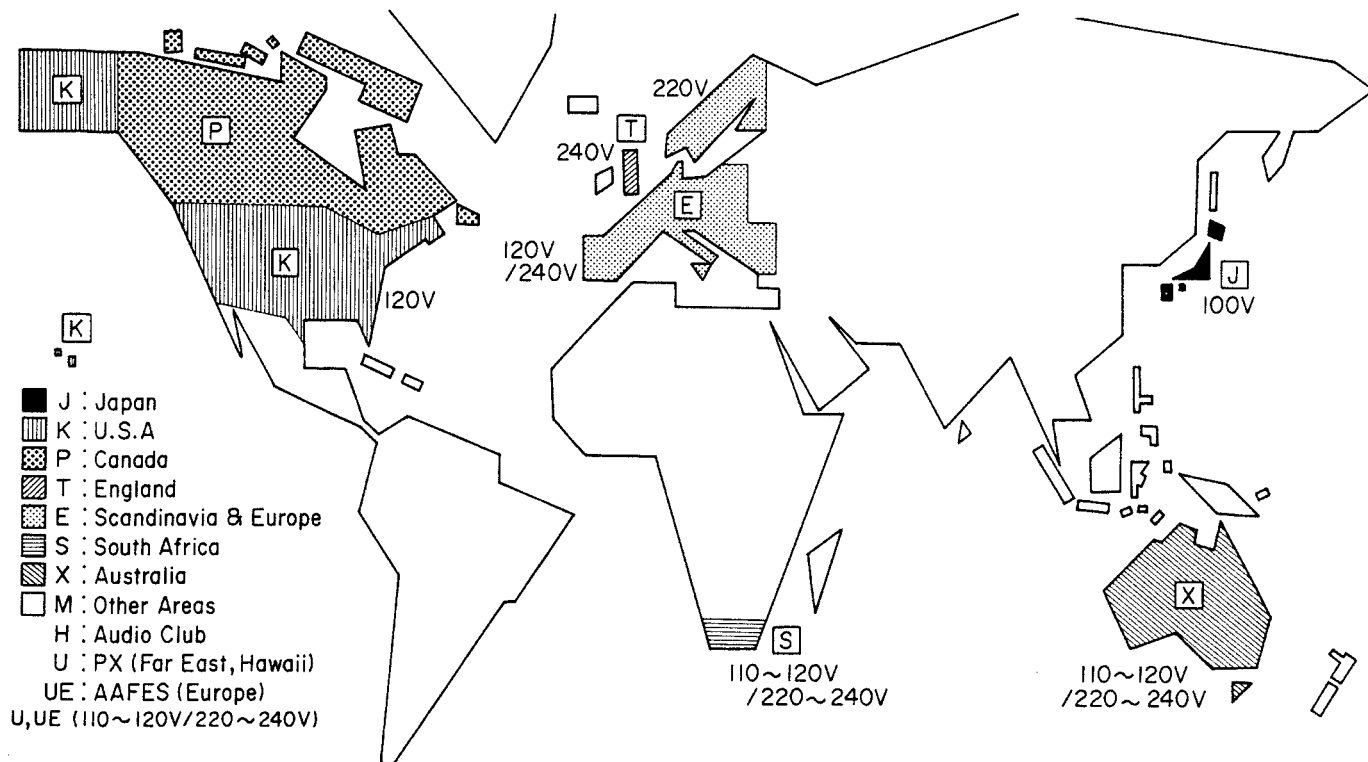

Note:

Component and circuitry are subject to modification to insure best operation under differing local conditions. This manual is based on, the U.S. (K) standard, and provides information on regional circuit modification through use of alternate schematic diagrams, and information on regional component variations through use of parts list.

There are no plan for producing units of S type.

A product of
TRIO-KENWOOD CORPORATION

6-17, 3-chome, Aobadai, Meguro-ku, Tokyo 153, Japan

KENWOOD ELECTRONICS, INC.

1315 E. Watsoncenter Rd. Carson, California 90745, U.S.A.
 75 Seaview Drive, Secaucus, New Jersey 07094, U.S.A.
 1098 North Tower Lane Bensenville, Illinois 60106, U.S.A.

TRIO-KENWOOD ELECTRONICS, N.V.

Leuvensesteenweg 504 B-1930 Zaventem, Belgium

TRIO-KENWOOD ELECTRONICS GmbH

Rudolf-Braas-Str. 20, 6056 Heusenstamm, West Germany

TRIO-KENWOOD FRANCE S.A.

5, Boulevard Ney, 75018 Paris, France

TRIO-KENWOOD SVENSKA AB

Kemistvagen 10A, S-183 21 Taby, Sweden

TRIO-KENWOOD (AUSTRALIA) PTY. LTD.

30 Whiting St., Artarmon, N.S.W. 2064, Australia

KENWOOD & LEE ELECTRONICS, LTD.

Room 501, Wang Kee Building, 5th Floor, 34-37, Connaught Road, Central, Hong Kong